

SIRUBA®

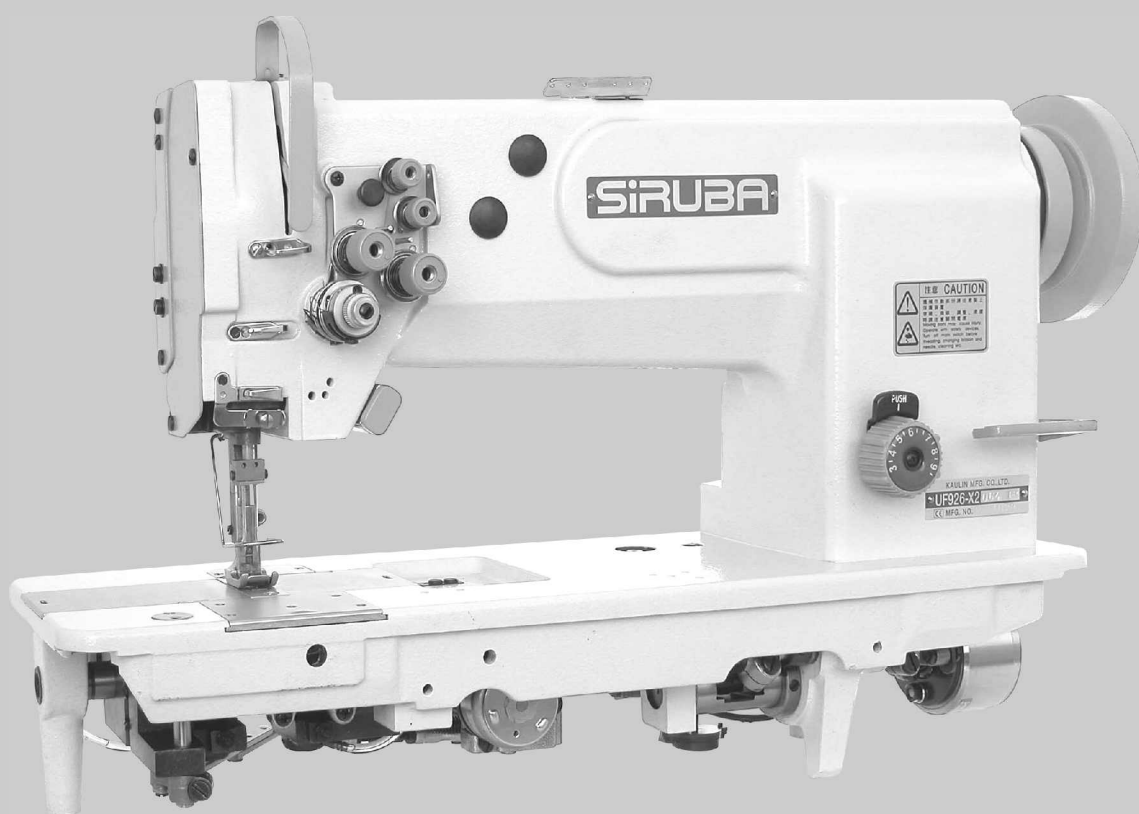







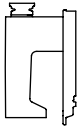

銀箭牌工業用縫紉機
INDUSTRIAL SEWING MACHINE

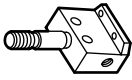
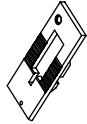
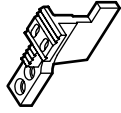
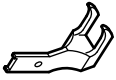
UF926/UF926^{WITH}TRIMMER



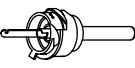

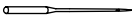



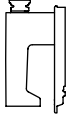

零件圖 PARTS LIST

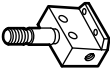
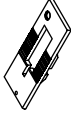
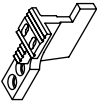



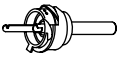



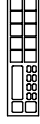

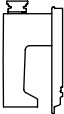

高林股份有限公司
KAULIN MFG. CO., LTD.

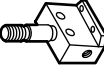
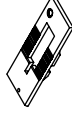
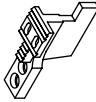



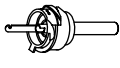

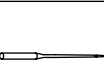

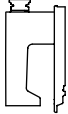

												
MODEL	SUB-CLASS	NEEDLE CLAMP	NEEDLE PLATE	FEED DOG	OUTER PRESSER FOOT	INNER PRESSER FOOT	SLIDE PLATE(L)	SLIDE PLATE(R)	HOOK ASM	BOBBIN	NEEDLE	SAFETY NEEDLE
機 型	規 格	針 釗	針 板	送 具	外 押 具	內 押 具	左 面 板	右 面 板	梭 頭	梭 子	針 號	針防護桿
UF926-X2-032	3.2mm(1/8)	M7032	E684	D684	P684	P685	UA202	UA203	G165	G310	DP17#23	UA131
UF926-X2-040	4.0mm(5/32)	M7040	E684P	D684P	P684P	P685P	UA202	UA203	G165	G310	DP17#23	UA131
UF926-X2-048	4.8mm(3/16)	M7048	E684Q	D684Q	P684Q	P685Q	UA202	UA203	G165	G310	DP17#23	UA131
UF926-X2-064	6.4mm(1/4)	M7064	E684R	D684R	P684R	P685R	UA202	UA203	G165	G310	DP17#23	UA131
UF926-X2-080	8.0mm(5/16)	M7080	E684S	D684S	P684S	P685S	UA202	UA203	G165	G310	DP17#23	UA131
UF926-X2-095	9.5mm(3/8)	M7095	E684T	D684T	P684T	P685T	UA202	UA203	G165	G310	DP17#23	UA212
UF926-X2-127	12.7mm(1/2)	M7127	E684U	D684U	P684U	P685U	UA202	UA203	G165	G310	DP17#23	UA212
UF926-X2-160	16.0mm(5/8)	M7160	E684V	D684V	P684V	P685V	UA202	UA203	G165	G310	DP17#23	UA212
UF926-X2-190	19.0mm(3/4)	M7190	E684W	D684W	P684W	P685W	UA202	UA203	G165	G310	DP17#23	UA213
UF926-X2-254	25.4mm(1)	M7254	E684X	D684X	P684X	P685X	UA202	UA203	G165	G310	DP17#23	UA213

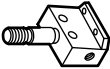
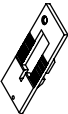
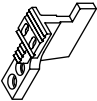
[illegible]



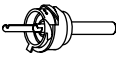





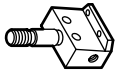
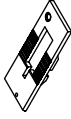
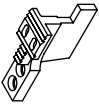

													
MODEL	SUB-CLASS	NEEDLE CLAMP	NEEDLE PLATE	FEED DOG	OUTER PRESSER FOOT	INNER PRESSER FOOT	SLIDE PLATE(L)	SLIDE PLATE(R)	HOOK ASM	BOBBIN	NEEDLE	SAFETY NEEDLE	OPERATING PANEL
機 型	規 格	針 釧	針 板	送 具	外 押 具	內 押 具	左 面 板	右 面 板	梭 頭	梭 子	針 號	針防護桿	操 作 盒
UF926-X2-040-A	4.0mm(5/32)	M7040	E685P	D685P	P684P	P685P	UA252	UA253	G173 G172	G310 G310	DP17#23	UA134	—
UF926-X2L-040-A													
UF926-X2-040-B	4.0mm(5/32)	M7040	E685P	D685P	P684P	P685P	UA252	UA253	G173	G310	DP17#23	UA134	—
UF926-X2-040-BP													
UF926-X2L-040-B	4.0mm(5/32)	M7040	E685P	D685P	P684P	P685P	UA252	UA253	G172	G310	DP17#23	UA134	—
UF926-X2L-040-BP													
UF926-X2-040-C	4.0mm(5/32)	M7040	E685P	D685P	P684P	P685P	UA252	UA253	G173 G172	G310 G310	DP17#23	UA134	—
UF926-X2L-040-C													
UF926-X2-040-D	4.0mm(5/32)	M7040	E685P	D685P	P684P	P685P	UA252	UA253	G173	G310	DP17#23	UA134	—
UF926-X2-040-DP													
UF926-X2L-040-D	4.0mm(5/32)	M7040	E685P	D685P	P684P	P685P	UA252	UA253	G172	G310	DP17#23	UA134	—
UF926-X2L-040-DP													
UF926-X2-040-E	4.0mm(5/32)	M7040	E685P	D685P	P684P	P685P	UA252	UA253	G173 G172	G310 G310	DP17#23	UA134	C300M-A1
UF926-X2L-040-E													
UF926-X2-040-F	4.0mm(5/32)	M7040	E685P	D685P	P684P	P685P	UA252	UA253	G173	G310	DP17#23	UA134	C300M-A1
UF926-X2-040-FP													
UF926-X2L-040-F	4.0mm(5/32)	M7040	E685P	D685P	P684P	P685P	UA252	UA253	G172	G310	DP17#23	UA134	C300M-A1
UF926-X2L-040-FP													

型別件對照表 MODEL COMPARE LIST



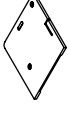
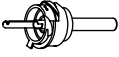



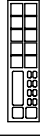

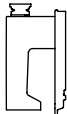

													
MODEL	SUB-CLASS	NEEDLE CLAMP	NEEDLE PLATE	FEED DOG	OUTER PRESSER FOOT	INNER PRESSER FOOT	SLIDE PLATE(L)	SLIDE PLATE(R)	HOOK ASM	BOBBIN	NEEDLE	SAFETY NEEDLE	OPERATING PANEL
機 型	規 格	針 鉗	針 板	送 具	外 押 具	內 押 具	左 面 板	右 面 板	梭 頭	梭 子	針 號	針防護桿	操 作 盒
UF926-X2-048-A	4.8mm(3/16)	M7048	E685Q	D685Q	P684Q	P685Q	UA252	UA253	G173 G172	G310 G310	DP17#23	UA134	—
UF926-X2-048-B	4.8mm(3/16)	M7048	E685Q	D685Q	P684Q	P685Q	UA252	UA253	G173	G310	DP17#23	UA134	—
UF926-X2L-048-BP	4.8mm(3/16)	M7048	E685Q	D685Q	P684Q	P685Q	UA252	UA253	G172	G310	DP17#23	UA134	—
UF926-X2-048-C	4.8mm(3/16)	M7048	E685Q	D685Q	P684Q	P685Q	UA252	UA253	G173 G172	G310 G310	DP17#23	UA134	—
UF926-X2L-048-C	4.8mm(3/16)	M7048	E685Q	D685Q	P684Q	P685Q	UA252	UA253	G172	G310	DP17#23	UA134	—
UF926-X2-048-D	4.8mm(3/16)	M7048	E685Q	D685Q	P684Q	P685Q	UA252	UA253	G173	G310	DP17#23	UA134	—
UF926-X2L-048-DP	4.8mm(3/16)	M7048	E685Q	D685Q	P684Q	P685Q	UA252	UA253	G172	G310	DP17#23	UA134	—
UF926-X2L-048-E	4.8mm(3/16)	M7048	E685Q	D685Q	P684Q	P685Q	UA252	UA253	G173 G172	G310 G310	DP17#23	UA134	C300M-A1
UF926-X2-048-F	4.8mm(3/16)	M7048	E685Q	D685Q	P684Q	P685Q	UA252	UA253	G173	G310	DP17#23	UA134	C300M-A1
UF926-X2L-048-FP	4.8mm(3/16)	M7048	E685Q	D685Q	P684Q	P685Q	UA252	UA253	G172	G310	DP17#23	UA134	C300M-A1

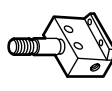
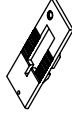
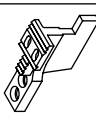



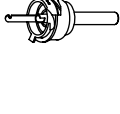

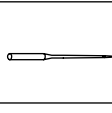



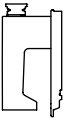

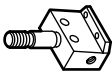
													
MODEL	SUB-CLASS	NEEDLE CLAMP	NEEDLE PLATE	FEED DOG	OUTER PRESSER FOOT	INNER PRESSER FOOT	SLIDE PLATE(L)	SLIDE PLATE(R)	HOOK ASM	BOBBIN	NEEDLE	SAFETY NEEDLE	OPERATING PANEL
機 型	規 格	針 釧	針 板	送 具	外 押 具	內 押 具	左 面 板	右 面 板	梭 頭	梭 子	針 號	針防護桿	操 作 盒
UF926-X2-064-A	6.4mm(1/4)	M7064	E685R	D685R	P684R	P685R	UA252	UA253	G173	G310	DP17#23	UA134	—
UF926-X2L-064-A									G172	G310			
UF926-X2-064-B	6.4mm(1/4)	M7064	E685R	D685R	P684R	P685R	UA252	UA253	G173	G310	DP17#23	UA134	—
UF926-X2-064-BP													
UF926-X2L-064-B	6.4mm(1/4)	M7064	E685R	D685R	P684R	P685R	UA252	UA253	G172	G310	DP17#23	UA134	—
UF926-X2L-064-BP													
UF926-X2-064-C	6.4mm(1/4)	M7064	E685R	D685R	P684R	P685R	UA252	UA253	G173	G310	DP17#23	UA134	—
UF926-X2L-064-C									G172	G310			
UF926-X2-064-D	6.4mm(1/4)	M7064	E685R	D685R	P684R	P685R	UA252	UA253	G173	G310	DP17#23	UA134	—
UF926-X2-064-DP													
UF926-X2L-064-D	6.4mm(1/4)	M7064	E685R	D685R	P684R	P685R	UA252	UA253	G172	G310	DP17#23	UA134	—
UF926-X2L-064-DP													
UF926-X2-064-E	6.4mm(1/4)	M7064	E685R	D685R	P684R	P685R	UA252	UA253	G173	G310	DP17#23	UA134	C300M-A1
UF926-X2L-064-E									G172	G310			
UF926-X2-064-F	6.4mm(1/4)	M7064	E685R	D685R	P684R	P685R	UA252	UA253	G173	G310	DP17#23	UA134	C300M-A1
UF926-X2-064-FP													
UF926-X2L-064-F	6.4mm(1/4)	M7064	E685R	D685R	P684R	P685R	UA252	UA253	G172	G310	DP17#23	UA134	C300M-A1
UF926-X2L-064-FP													

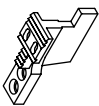
[illegible]



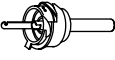

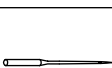



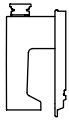

													
MODEL	SUB-CLASS	NEEDLE CLAMP	NEEDLE PLATE	FEED DOG	OUTER PRESSER FOOT	INNER PRESSER FOOT	SLIDE PLATE(L)	SLIDE PLATE(R)	HOOK ASM	BOBBIN	NEEDLE	SAFETY NEEDLE	OPERATING PANEL
機 型	規 格	針 釧	針 板	送 具	外 押 具	內 押 具	左 面 板	右 面 板	梭 頭	梭 子	針 號	針防護桿	操 作 盒
UF926-X2-095-A	9.5mm(3/8)	M7095	E685T	D685T	P684T	P685T	UA252	UA253	G173 G172	G310 G310	DP17#23	UA212	—
UF926-X2L-095-A													
UF926-X2-095-B	9.5mm(3/8)	M7095	E685T	D685T	P684T	P685T	UA252	UA253	G173	G310	DP17#23	UA212	—
UF926-X2-095-BP													
UF926-X2L-095-B	9.5mm(3/8)	M7095	E685T	D685T	P684T	P685T	UA252	UA253	G172	G310	DP17#23	UA212	—
UF926-X2L-095-BP													
UF926-X2-095-C	9.5mm(3/8)	M7095	E685T	D685T	P684T	P685T	UA252	UA253	G173 G172	G310 G310	DP17#23	UA212	—
UF926-X2L-095-C													
UF926-X2-095-D	9.5mm(3/8)	M7095	E685T	D685T	P684T	P685T	UA252	UA253	G173	G310	DP17#23	UA212	—
UF926-X2-095-DP													
UF926-X2L-095-D	9.5mm(3/8)	M7095	E685T	D685T	P684T	P685T	UA252	UA253	G172	G310	DP17#23	UA212	—
UF926-X2L-095-DP													
UF926-X2-095-E	9.5mm(3/8)	M7095	E685T	D685T	P684T	P685T	UA252	UA253	G173 G172	G310 G310	DP17#23	UA212	C300M-A1
UF926-X2L-095-E													
UF926-X2-095-F	9.5mm(3/8)	M7095	E685T	D685T	P684T	P685T	UA252	UA253	G173	G310	DP17#23	UA212	C300M-A1
UF926-X2-095-FP													
UF926-X2L-095-F	9.5mm(3/8)	M7095	E685T	D685T	P684T	P685T	UA252	UA253	G172	G310	DP17#23	UA212	C300M-A1
UF926-X2L-095-FP													

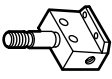
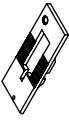
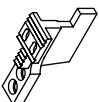
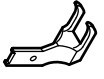



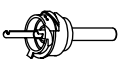

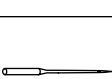



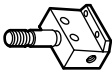

型別件對照表 MODEL COMPARE LIST

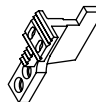
													
MODEL	SUB-CLASS	NEEDLE CLAMP	NEEDLE PLATE	FEED DOG	OUTER PRESSER FOOT	INNER PRESSER FOOT	SLIDE PLATE(L)	SLIDE PLATE(R)	HOOK ASM	BOBBIN	NEEDLE	SAFETY NEEDLE	OPERATING PANEL
機 型	規 格	針 釧	針 板	送 具	外 押 具	內 押 具	左 面 板	右 面 板	梭 頭	梭 子	針 號	針防護桿	操 作 盒
UF926-X2-127-A	12.7mm(1/2)	M7127	E685U	D685U	P684U	P685U	UA252	UA253	G173 G172	G310 G310	DP17#23	UA212	—
UF926-X2-127-B	12.7mm(1/2)	M7127	E685U	D685U	P684U	P685U	UA252	UA253	G173	G310	DP17#23	UA212	—
UF926-X2-127-BP	12.7mm(1/2)	M7127	E685U	D685U	P684U	P685U	UA252	UA253	G172	G310	DP17#23	UA212	—
UF926-X2-127-C	12.7mm(1/2)	M7127	E685U	D685U	P684U	P685U	UA252	UA253	G173 G172	G310 G310	DP17#23	UA212	—
UF926-X2-127-D	12.7mm(1/2)	M7127	E685U	D685U	P684U	P685U	UA252	UA253	G173	G310	DP17#23	UA212	—
UF926-X2-127-DP	12.7mm(1/2)	M7127	E685U	D685U	P684U	P685U	UA252	UA253	G172	G310	DP17#23	UA212	—
UF926-X2-127-E	12.7mm(1/2)	M7127	E685U	D685U	P684U	P685U	UA252	UA253	G173 G172	G310 G310	DP17#23	UA212	C300M-A1
UF926-X2-127-F	12.7mm(1/2)	M7127	E685U	D685U	P684U	P685U	UA252	UA253	G173	G310	DP17#23	UA212	C300M-A1
UF926-X2L-127-FP	12.7mm(1/2)	M7127	E685U	D685U	P684U	P685U	UA252	UA253	G172	G310	DP17#23	UA212	C300M-A1

													
MODEL	SUB-CLASS	NEEDLE CLAMP	NEEDLE PLATE	FEED DOG	OUTER PRESSER FOOT	INNER PRESSER FOOT	SLIDE PLATE(L)	SLIDE PLATE(R)	HOOK ASM	BOBBIN	NEEDLE	SAFETY NEEDLE	OPERATING PANEL
機 型	規 格	針 鉗	針 板	送 具	外 押 具	內 押 具	左 面 板	右 面 板	梭 頭	梭 子	針 號	針防護桿	操 作 盒
UF926-X2-160-A	16.0mm(5/8)	M7160	E685V	D685V	P684V	P685V	UA252	UA253	G173	G310	DP17#23	UA212	—
UF926-X2L-160-A									G172	G310			
UF926-X2-160-B	16.0mm(5/8)	M7160	E685V	D685V	P684V	P685V	UA252	UA253	G173	G310	DP17#23	UA212	—
UF926-X2-160-BP													
UF926-X2L-160-B	16.0mm(5/8)	M7160	E685V	D685V	P684V	P685V	UA252	UA253	G172	G310	DP17#23	UA212	—
UF926-X2L-160-BP													
UF926-X2-160-C	16.0mm(5/8)	M7160	E685V	D685V	P684V	P685V	UA252	UA253	G173	G310	DP17#23	UA212	—
UF926-X2L-160-C									G172	G310			
UF926-X2-160-D	16.0mm(5/8)	M7160	E685V	D685V	P684V	P685V	UA252	UA253	G173	G310	DP17#23	UA212	—
UF926-X2-160-DP													
UF926-X2L-160-D	16.0mm(5/8)	M7160	E685V	D685V	P684V	P685V	UA252	UA253	G172	G310	DP17#23	UA212	—
UF926-X2L-160-DP													
UF926-X2-160-E	16.0mm(5/8)	M7160	E685V	D685V	P684V	P685V	UA252	UA253	G173	G310	DP17#23	UA212	C300M-A1
UF926-X2L-160-E									G172	G310			
UF926-X2-160-F	16.0mm(5/8)	M7160	E685V	D685V	P684V	P685V	UA252	UA253	G173	G310	DP17#23	UA212	C300M-A1
UF926-X2-160-FP													
UF926-X2L-160-F	16.0mm(5/8)	M7160	E685V	D685V	P684V	P685V	UA252	UA253	G172	G310	DP17#23	UA212	C300M-A1
UF926-X2L-160-FP													

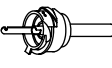
型別件對照表 MODEL COMPARE LIST

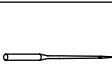
													
MODEL	SUB-CLASS	NEEDLE CLAMP	NEEDLE PLATE	FEED DOG	OUTER PRESSER FOOT	INNER PRESSER FOOT	SLIDE PLATE(L)	SLIDE PLATE(R)	HOOK ASM	BOBBIN	NEEDLE	SAFETY NEEDLE	OPERATING PANEL
機 型	規 格	針 鉗	針 板	送 具	外 押 具	內 押 具	左 面 板	右 面 板	梭 頭	梭 子	針 號	針防護桿	操 作 盒
UF926-X2-190-A	19.0mm(3/4)	M7190	E685W	D685W	P684W	P685W	UA252	UA253	G173 G172	G310 G310	DP17#23	UA213	—
UF926-X2-190-B	19.0mm(3/4)	M7190	E685W	D685W	P684W	P685W	UA252	UA253	G173	G310	DP17#23	UA213	—
UF926-X2-190-BP	19.0mm(3/4)	M7190	E685W	D685W	P684W	P685W	UA252	UA253	G172	G310	DP17#23	UA213	—
UF926-X2-190-C	19.0mm(3/4)	M7190	E685W	D685W	P684W	P685W	UA252	UA253	G173 G172	G310 G310	DP17#23	UA213	—
UF926-X2-190-D	19.0mm(3/4)	M7190	E685W	D685W	P684W	P685W	UA252	UA253	G173	G310	DP17#23	UA213	—
UF926-X2-190-DP	19.0mm(3/4)	M7190	E685W	D685W	P684W	P685W	UA252	UA253	G172	G310	DP17#23	UA213	—
UF926-X2-190-E	19.0mm(3/4)	M7190	E685W	D685W	P684W	P685W	UA252	UA253	G173 G172	G310 G310	DP17#23	UA213	C300M-A1
UF926-X2-190-F	19.0mm(3/4)	M7190	E685W	D685W	P684W	P685W	UA252	UA253	G173	G310	DP17#23	UA213	C300M-A1
UF926-X2L-190-FP	19.0mm(3/4)	M7190	E685W	D685W	P684W	P685W	UA252	UA253	G172	G310	DP17#23	UA213	C300M-A1

													
MODEL	SUB-CLASS	NEEDLE CLAMP	NEEDLE PLATE	FEED DOG	OUTER PRESSER FOOT	INNER PRESSER FOOT	SLIDE PLATE(L)	SLIDE PLATE(R)	HOOK ASM	BOBBIN	NEEDLE	SAFETY NEEDLE	OPERATING PANEL
機 型	規 格	針 鉗	針 板	送 具	外 押 具	內 押 具	左 面 板	右 面 板	梭 頭	梭 子	針 號	針防護桿	操 作 盒
UF926-X2-254-A	25.4mm (1)	M7254	E685X	D685X	P684X	P685X	UA252	UA253	G173	G310	DP17#23	UA213	—
UF926-X2L-254-A									G172	G310			
UF926-X2-254-B	25.4mm (1)	M7254	E685X	D685X	P684X	P685X	UA252	UA253	G173	G310	DP17#23	UA213	—
UF926-X2-254-BP													
UF926-X2L-254-B	25.4mm (1)	M7254	E685X	D685X	P684X	P685X	UA252	UA253	G172	G310	DP17#23	UA213	—
UF926-X2L-254-BP													
UF926-X2-254-C	25.4mm (1)	M7254	E685X	D685X	P684X	P685X	UA252	UA253	G173	G310	DP17#23	UA213	—
UF926-X2L-254-C									G172	G310			
UF926-X2-254-D	25.4mm (1)	M7254	E685X	D685X	P684X	P685X	UA252	UA253	G173	G310	DP17#23	UA213	—
UF926-X2-254-DP													
UF926-X2L-254-D	25.4mm (1)	M7254	E685X	D685X	P684X	P685X	UA252	UA253	G172	G310	DP17#23	UA213	—
UF926-X2L-254-DP													
UF926-X2-254-E	25.4mm (1)	M7254	E685X	D685X	P684X	P685X	UA252	UA253	G173	G310	DP17#23	UA213	C300M-A1
UF926-X2L-254-E									G172	G310			
UF926-X2-254-F	25.4mm (1)	M7254	E685X	D685X	P684X	P685X	UA252	UA253	G173	G310	DP17#23	UA213	C300M-A1
UF926-X2-254-FP													
UF926-X2L-254-F	25.4mm (1)	M7254	E685X	D685X	P684X	P685X	UA252	UA253	G172	G310	DP17#23	UA213	C300M-A1
UF926-X2L-254-FP													

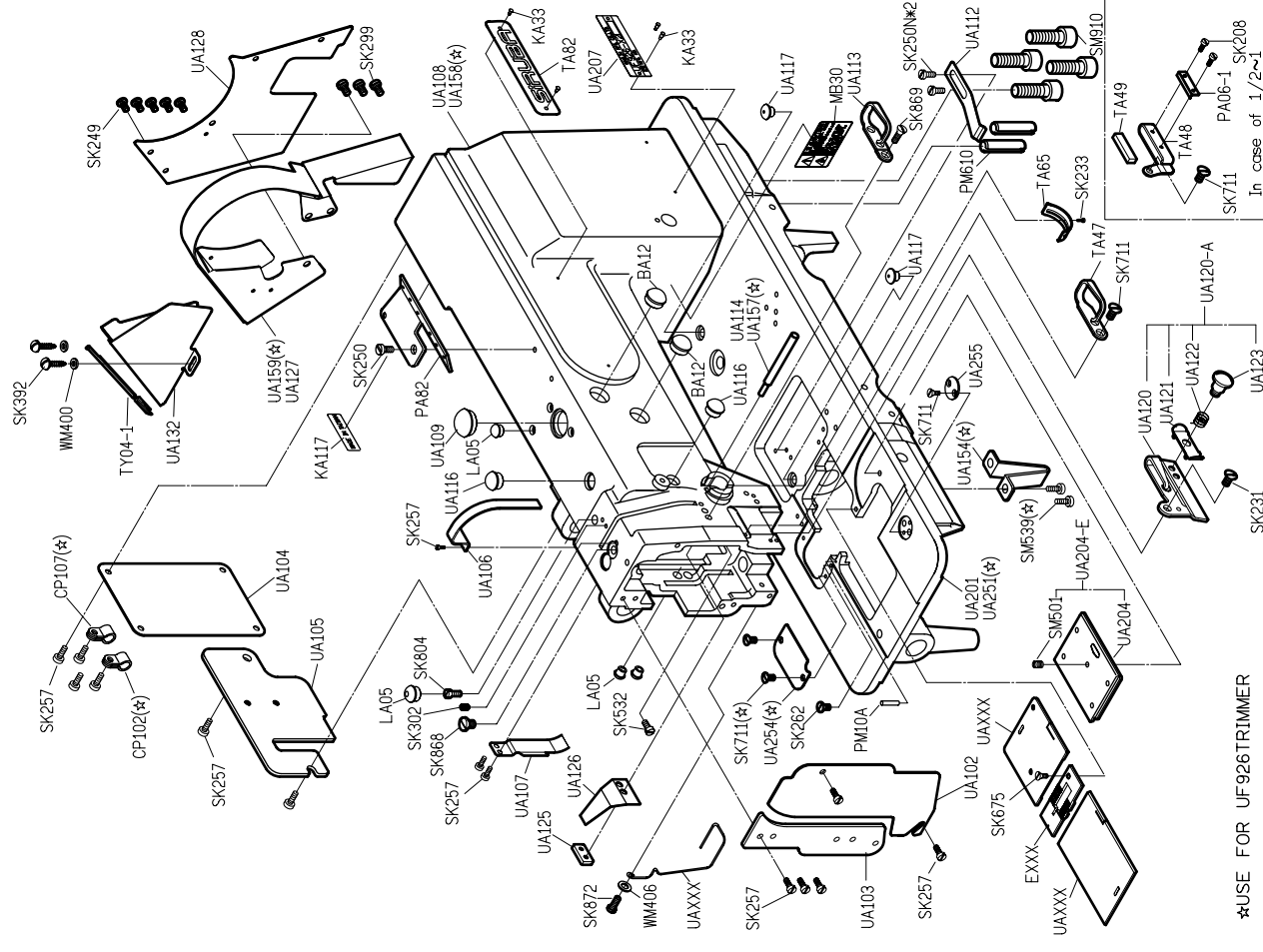

☆USE FOR UF926TRIMMER

In case of $1/2 \sim 1$

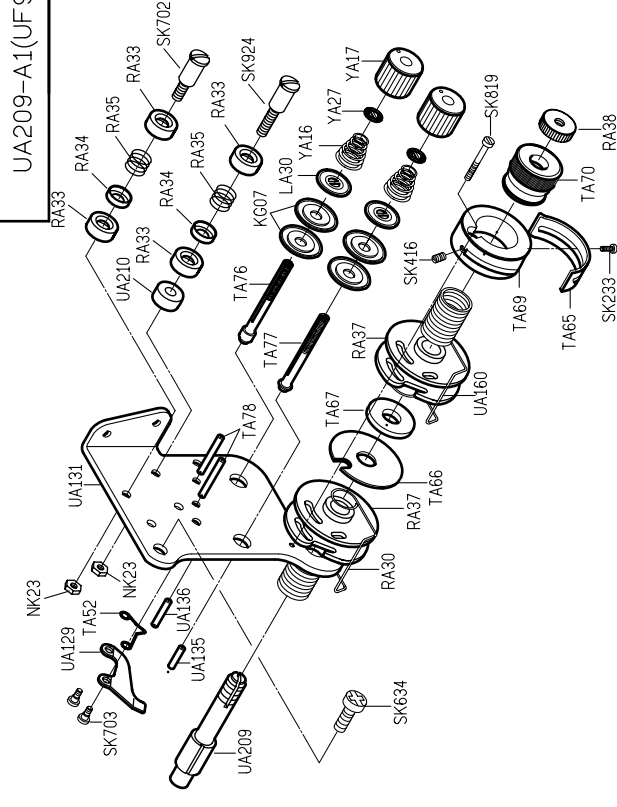

UA209-A1(UF926)

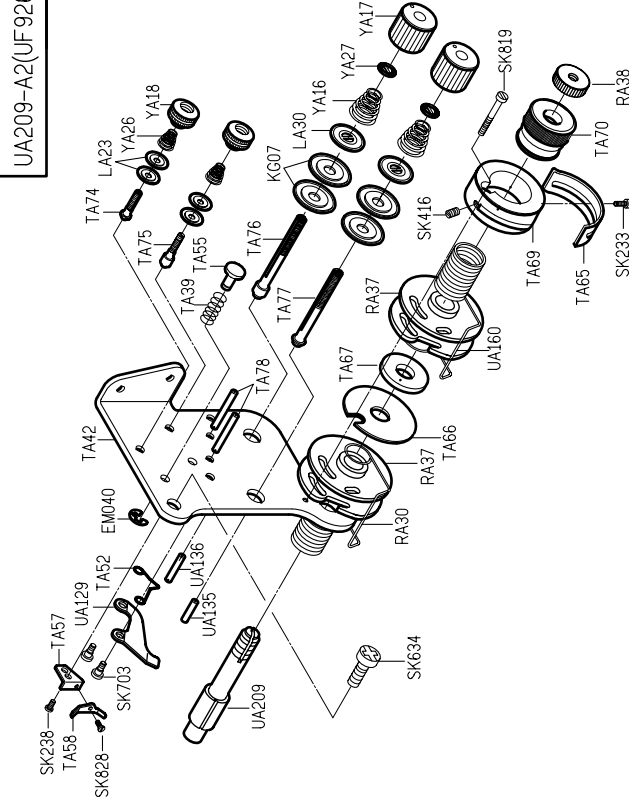

UA209-A2(UF926 TRIMMER)

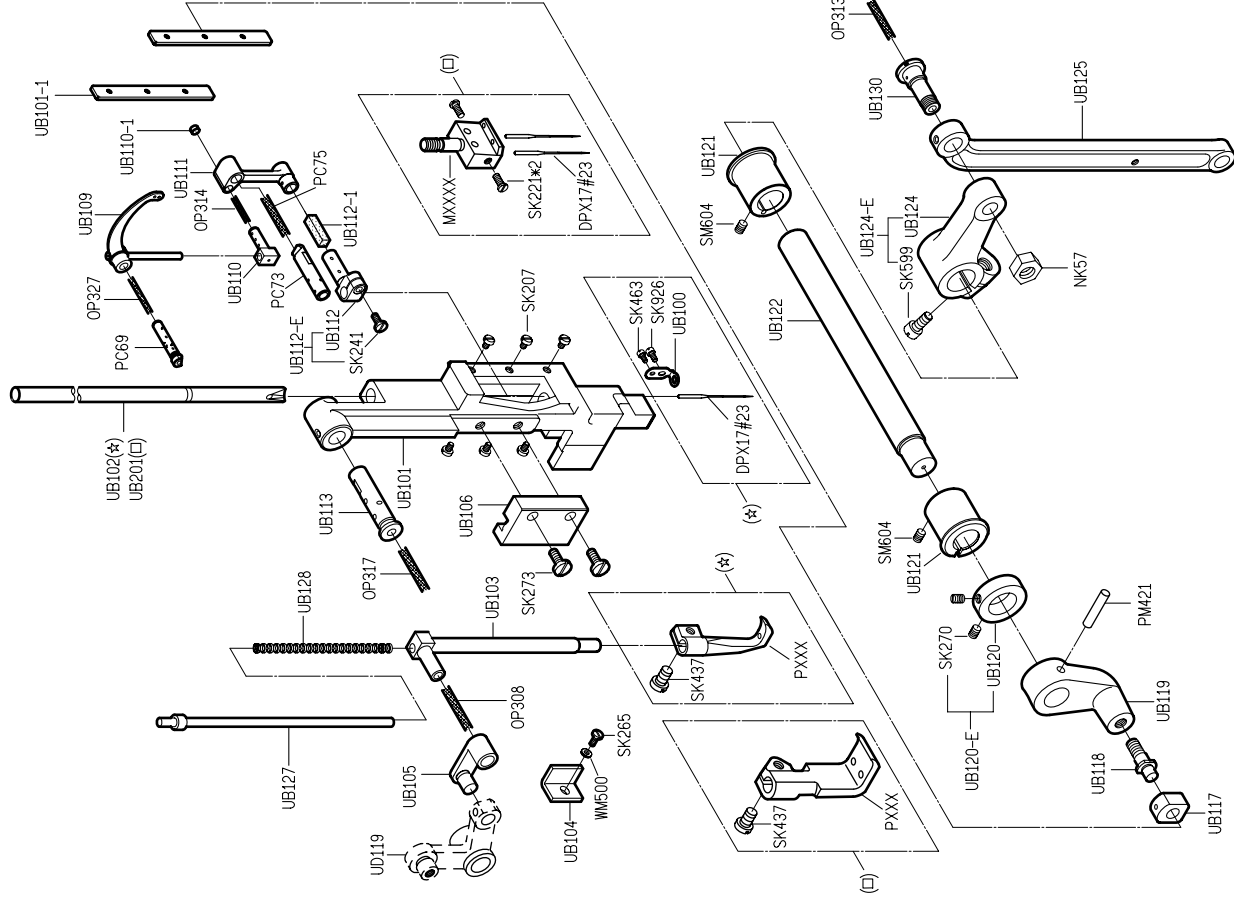

★USE FOR UF916/UF916 TRIMMER
 □USE FOR UF926/UF926 TRIMMER

PARTS LIST FOR UB GROUP

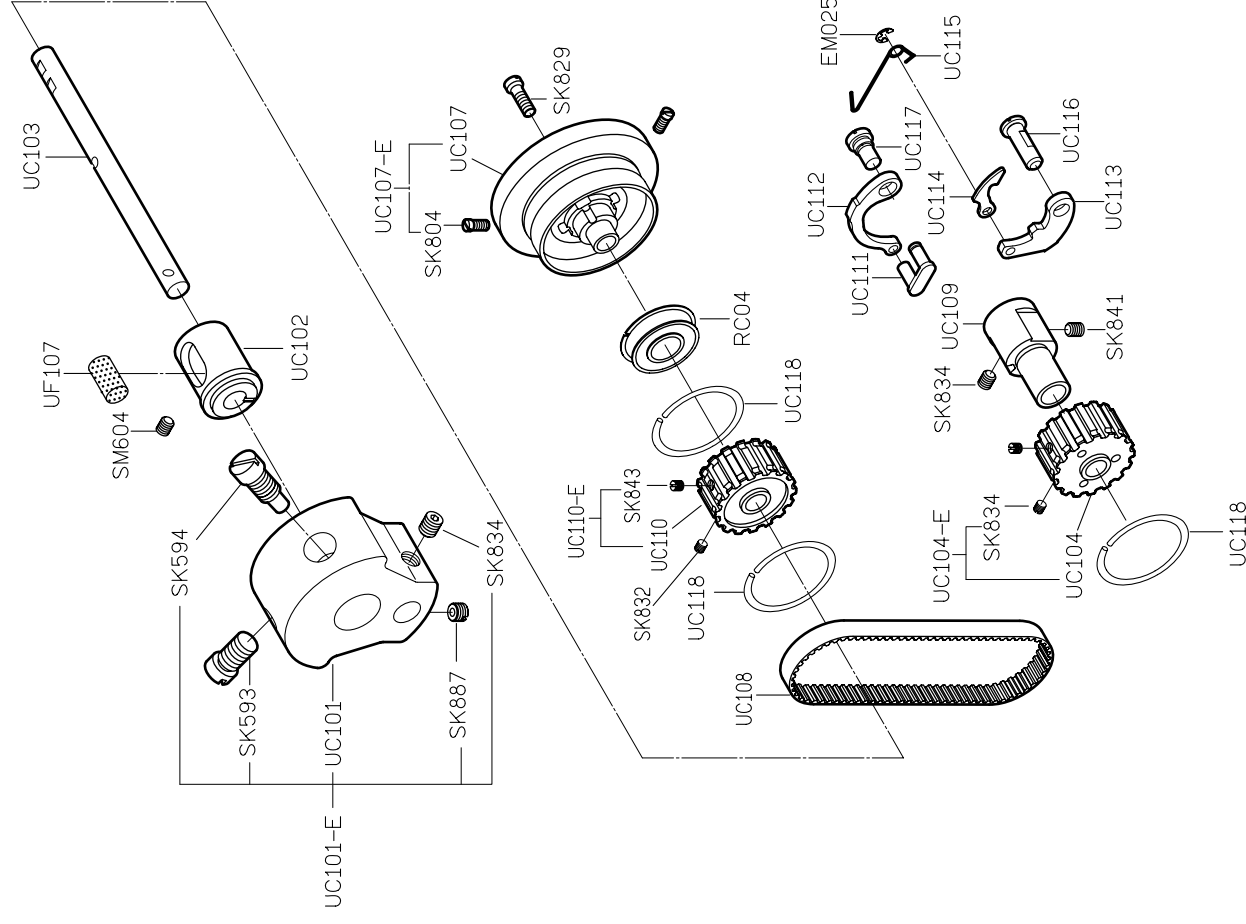

PARTS LIST FOR UC (UF926) GROUP

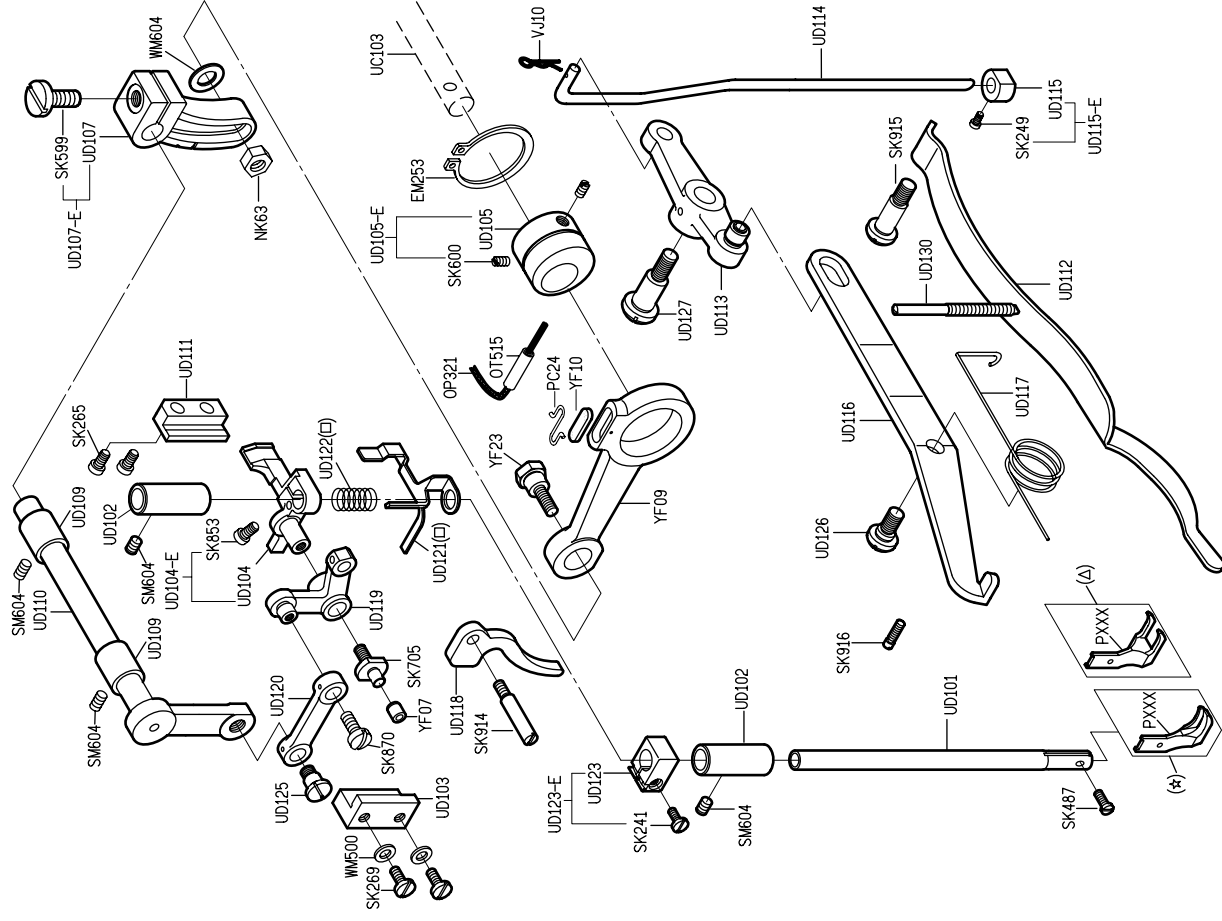

☆USE FOR UF916/UF916 TRIMMER	□USE FOR UF916/UF926
△USE FOR UF926/UF926 TRIMMER	

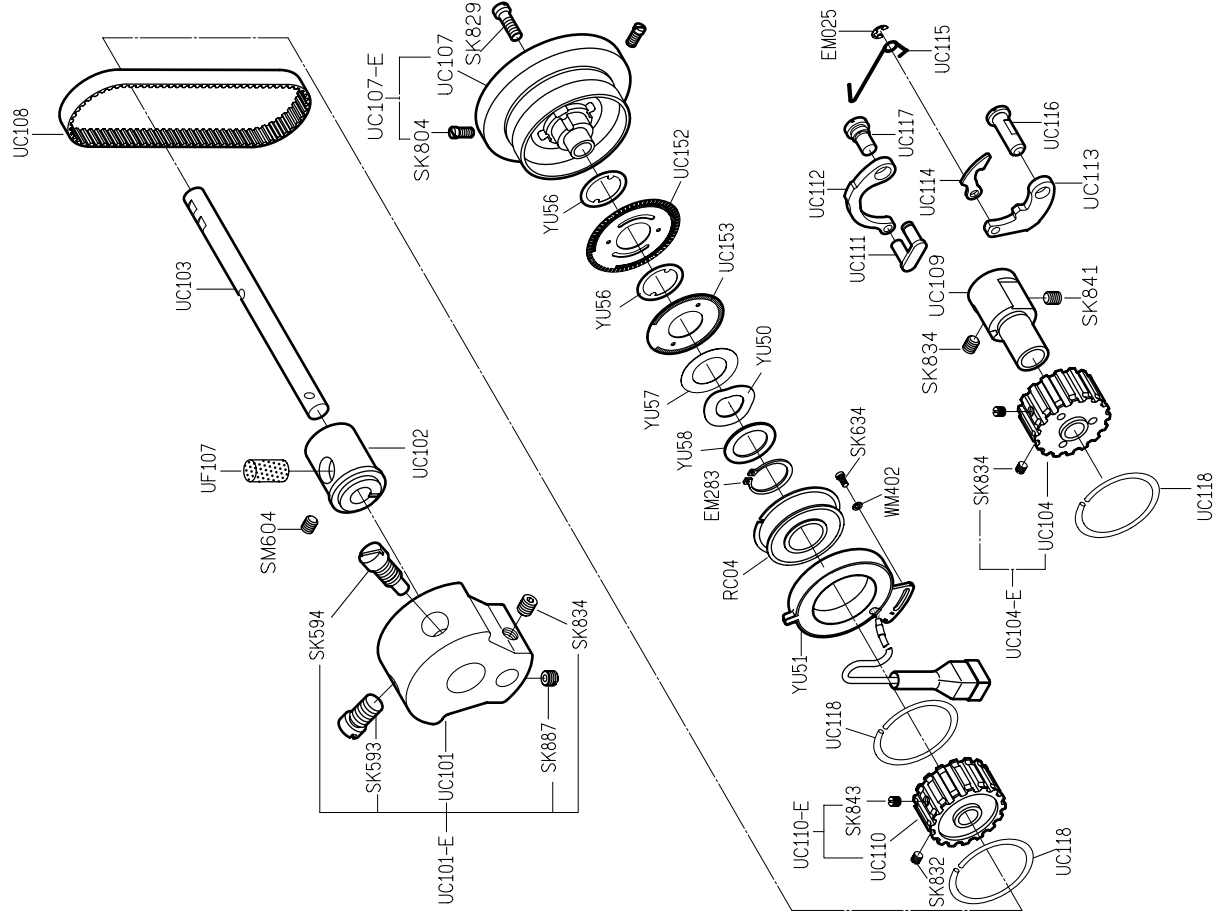

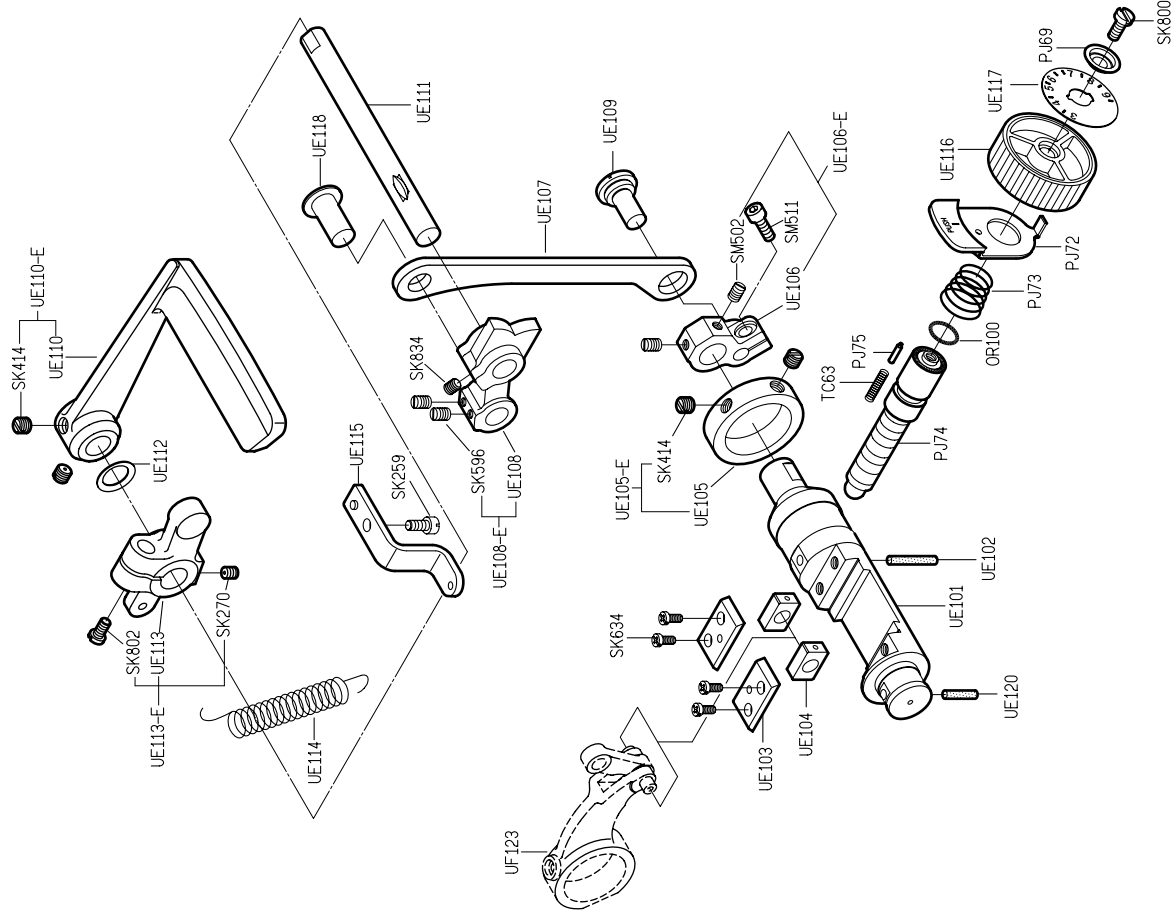
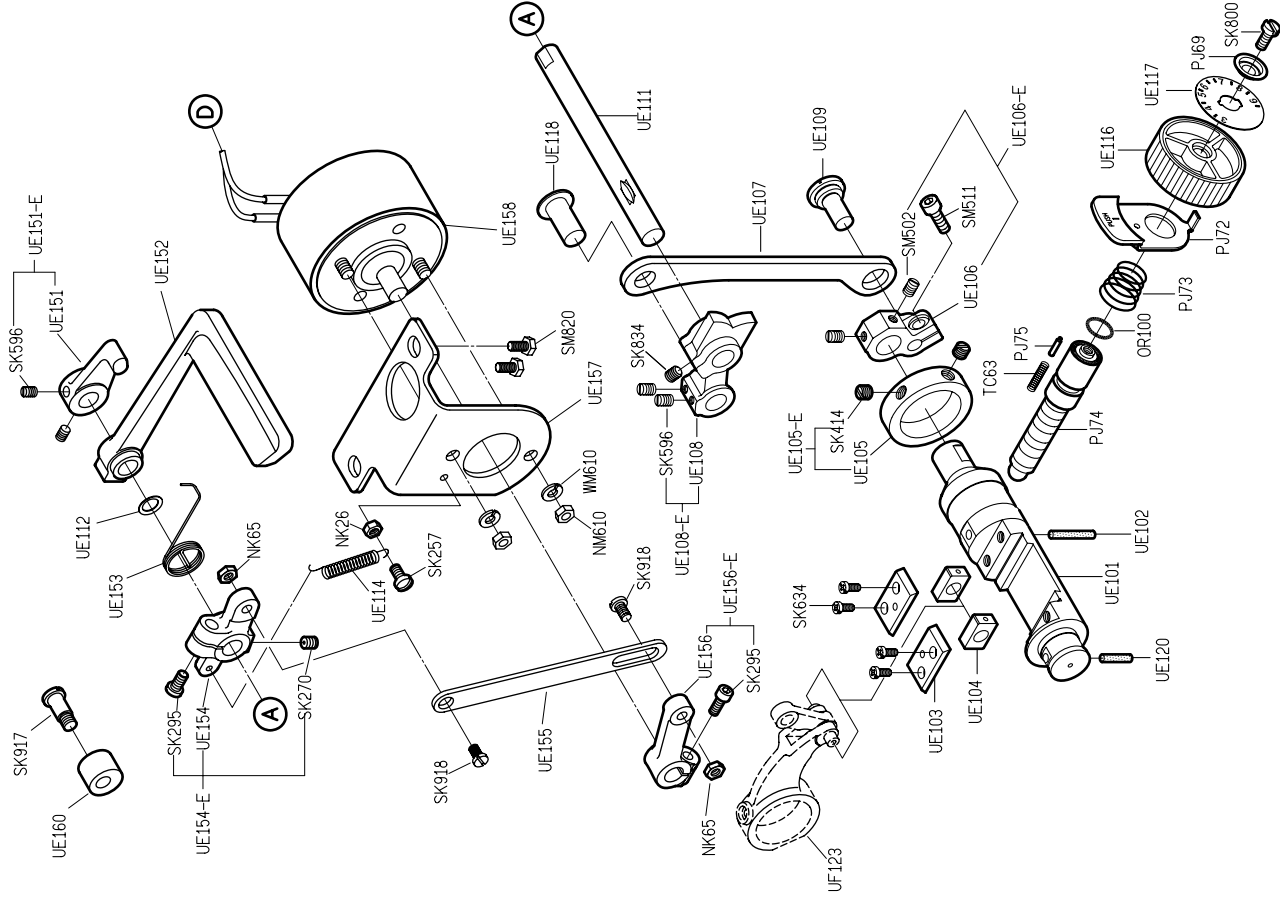

PARTS LIST FOR UE (UF926 TRIMMER) GROUP

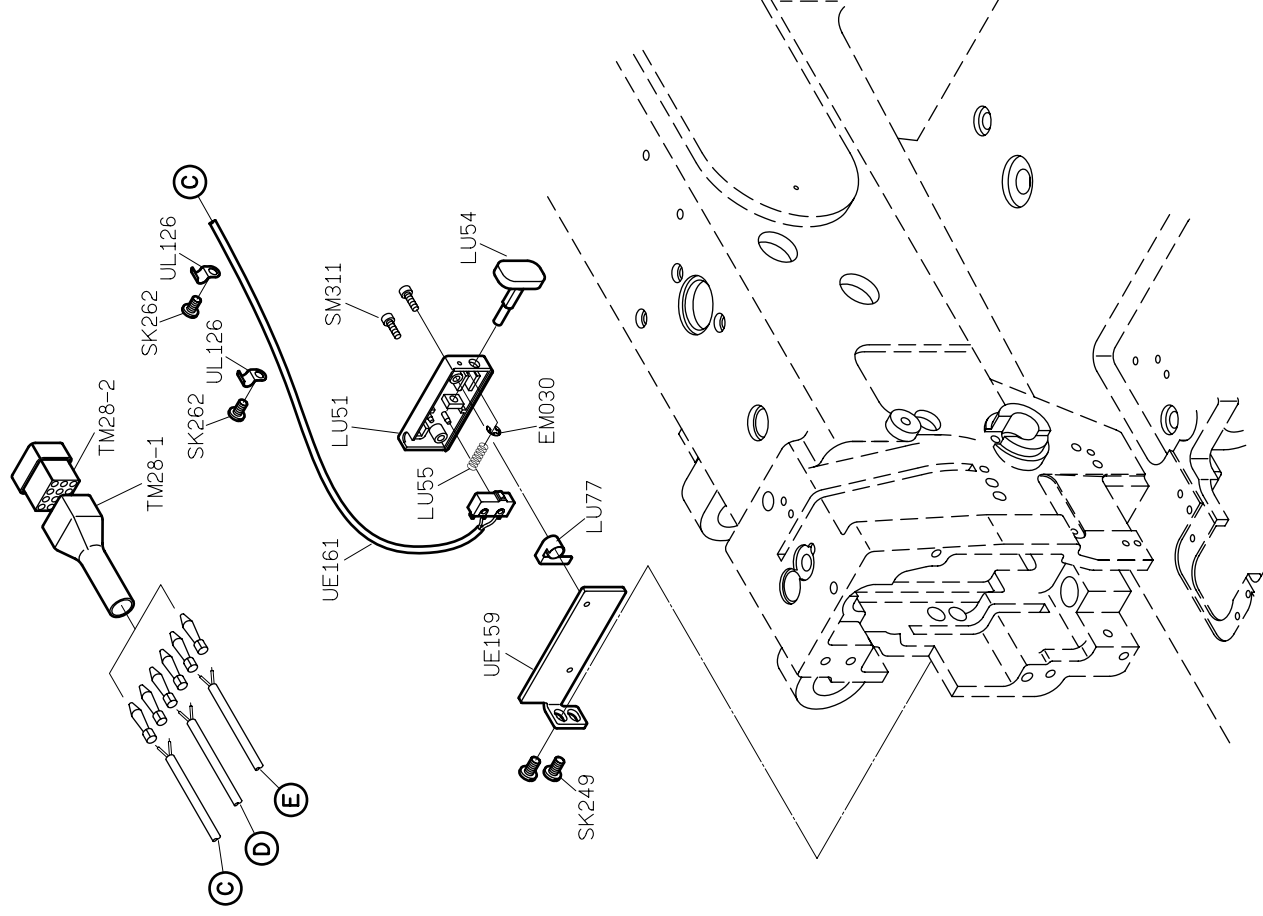

PARTS LIST FOR UF GROUP

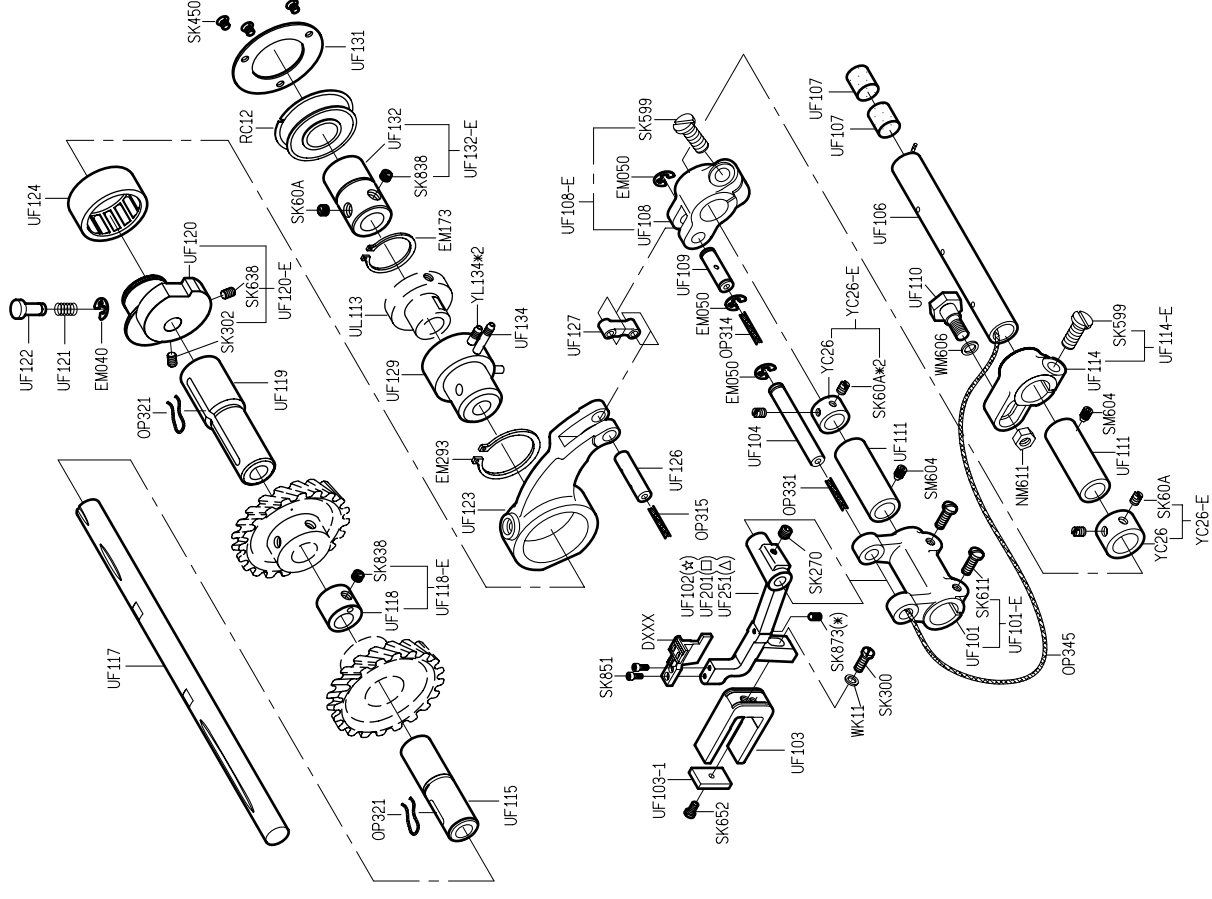

*USE FOR UF916/UF916TRIMMER *USE FOR UF926/UF926TRIMMER
 USE FOR UF926 USE FOR UF926 TRIMMER

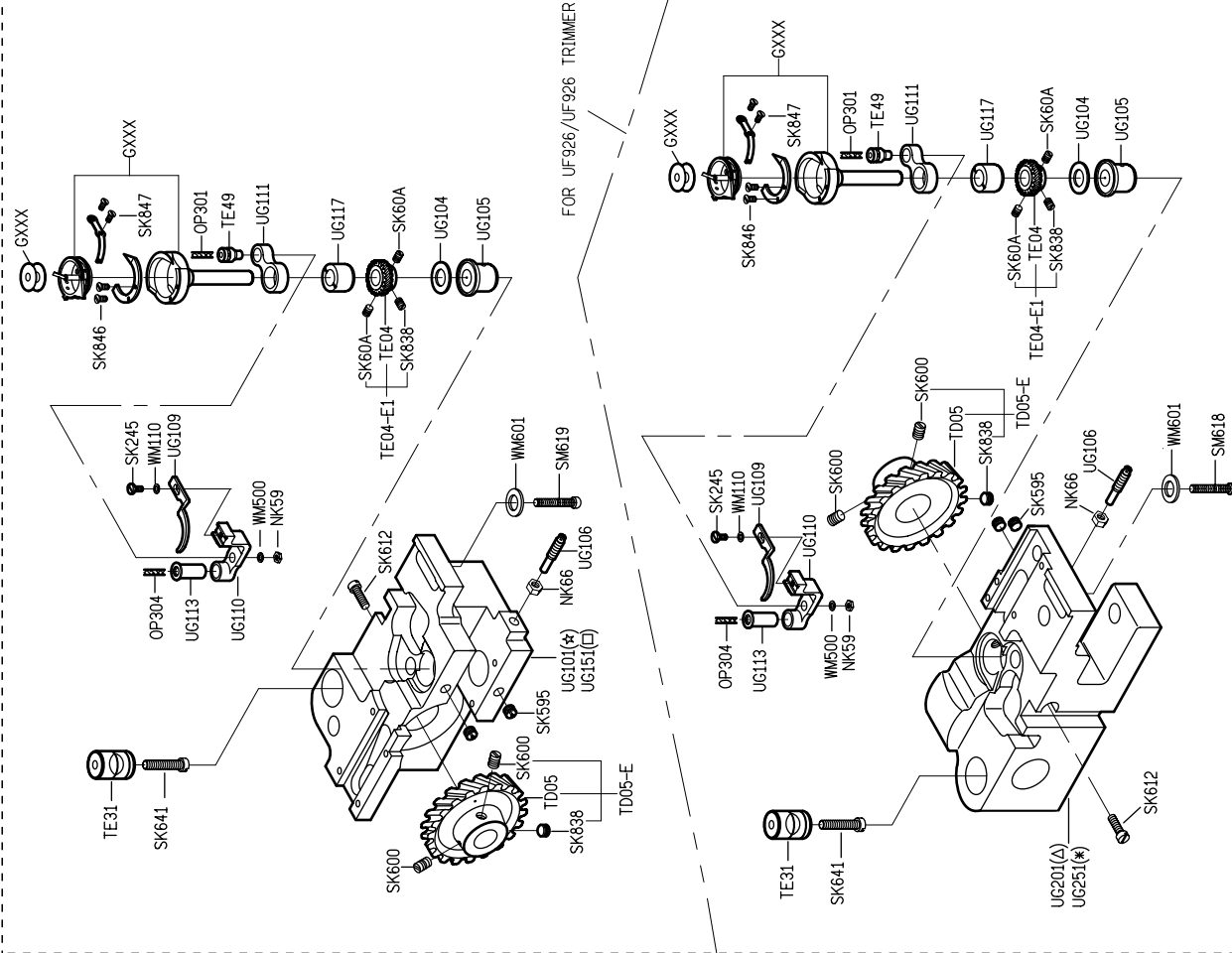

☆USE FOR UF916/UF926 □USE FOR UF916TRIMMER/UF926 TIRMER
△USE FOR UF926 *USE FOR UF926 TRIMMER

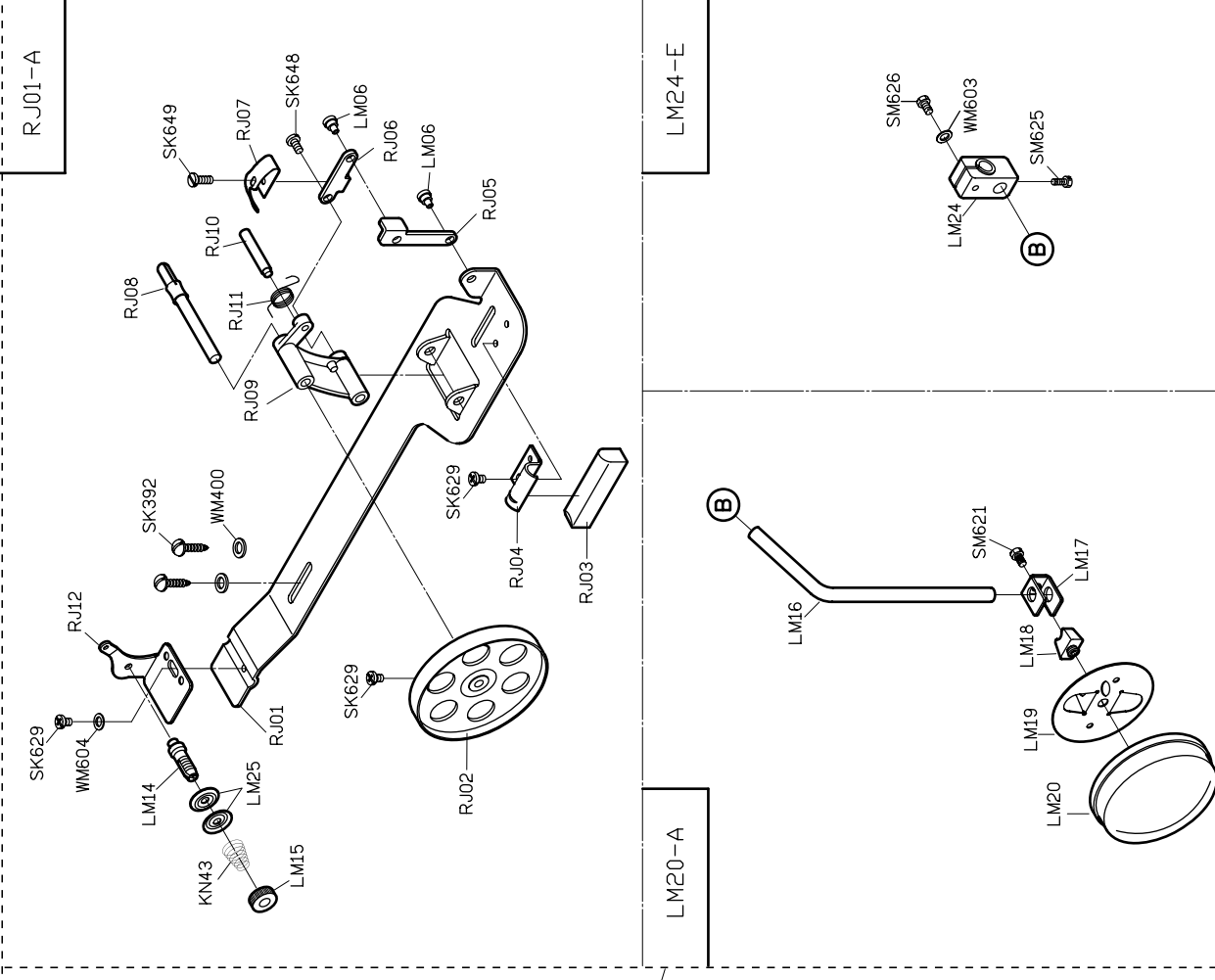

☆USE FOR UF916/UF926 □USE FOR UF916TRIMMER/UF926 TIRMER
△USE FOR UF926 *USE FOR UF926 TRIMMER

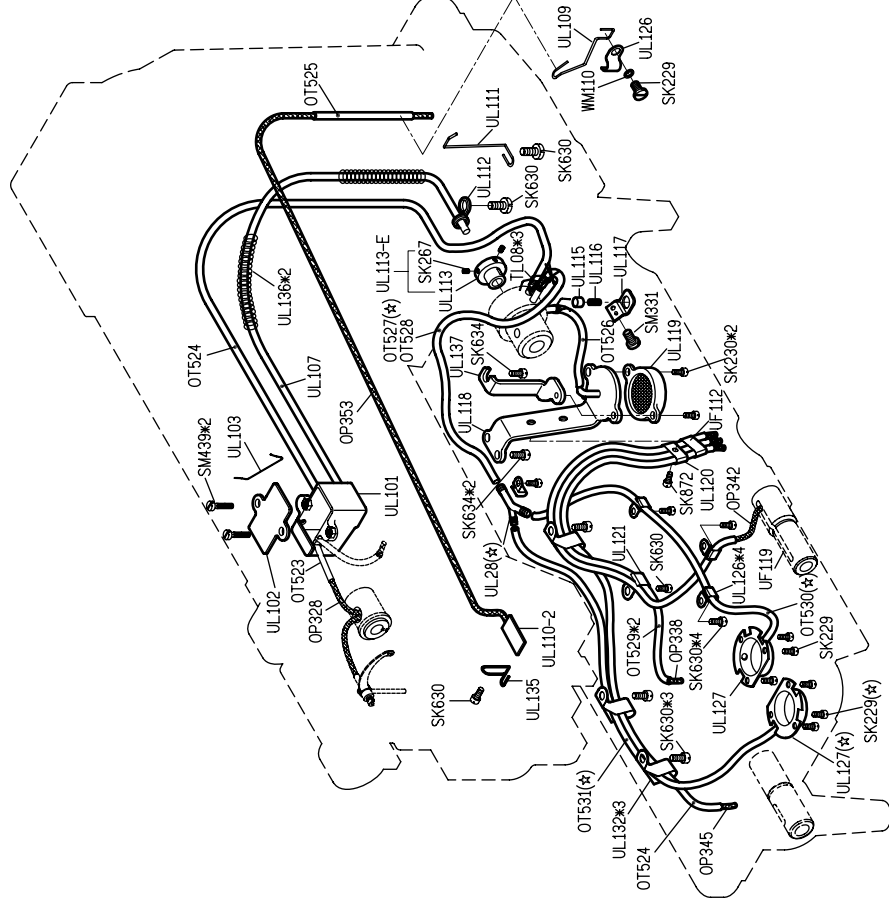

★USE FOR UF926/UF926 TRIMMER

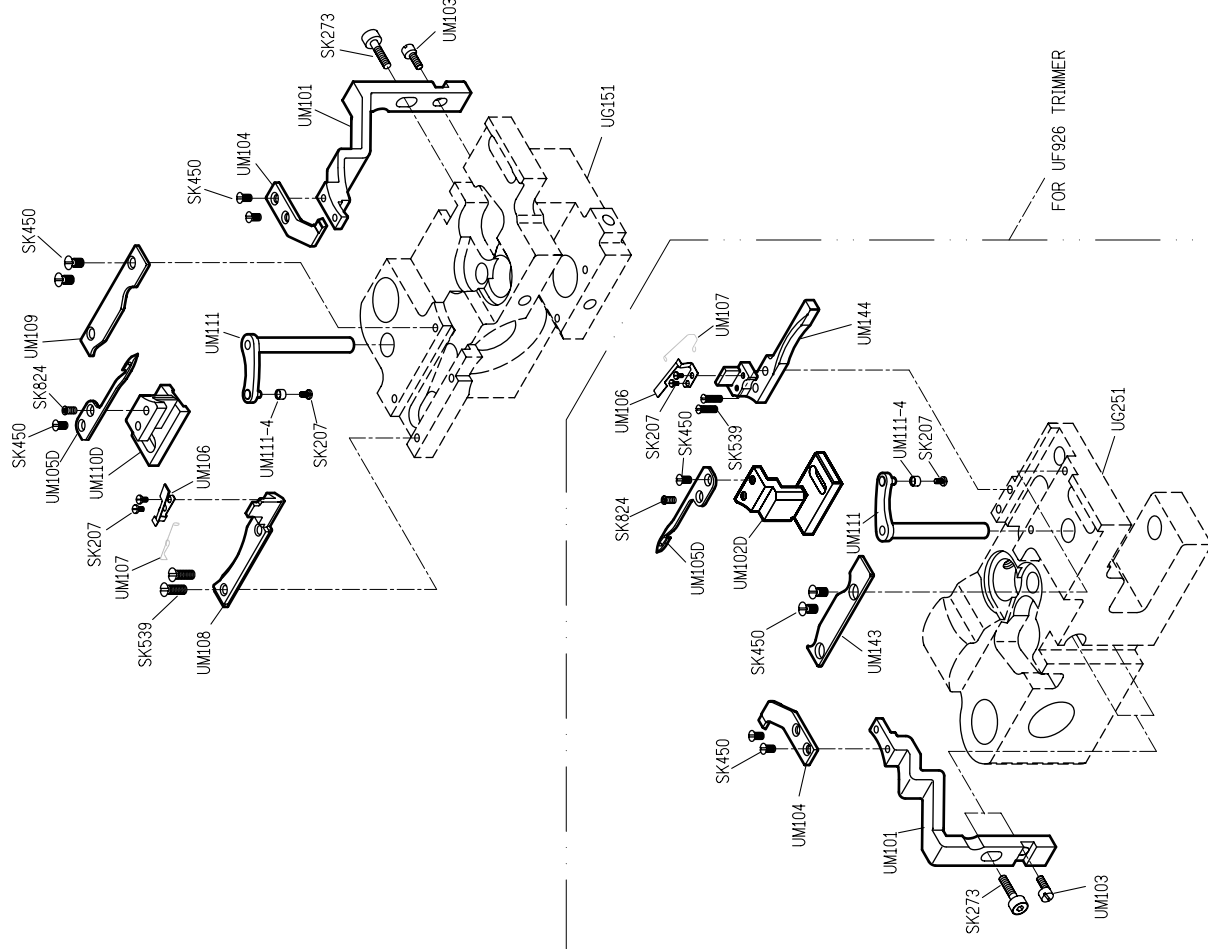

FOR UF926 TRIMMER

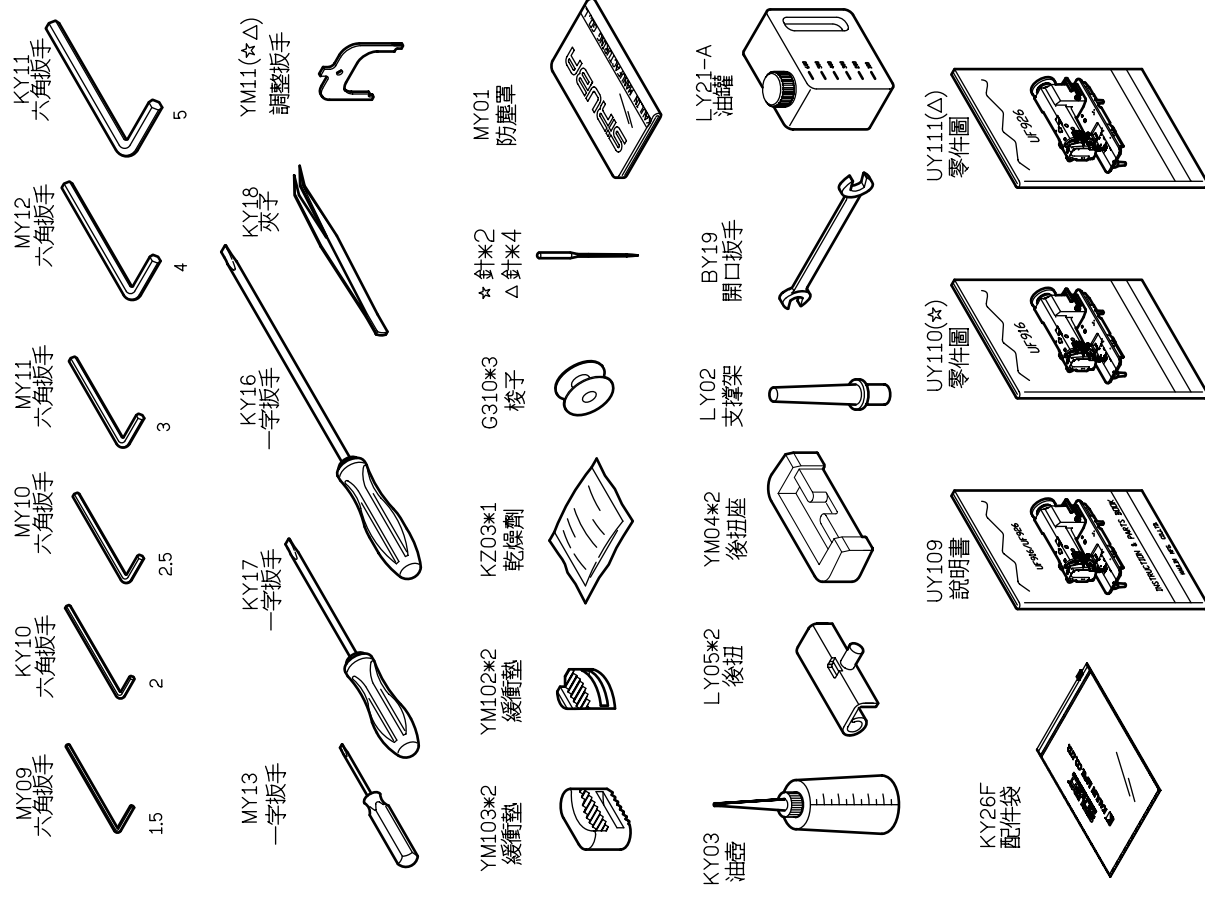

☆USE FOR UF916/UF916TRIMMER
ΔUSE FOR UF926/UF926 TRIMMER

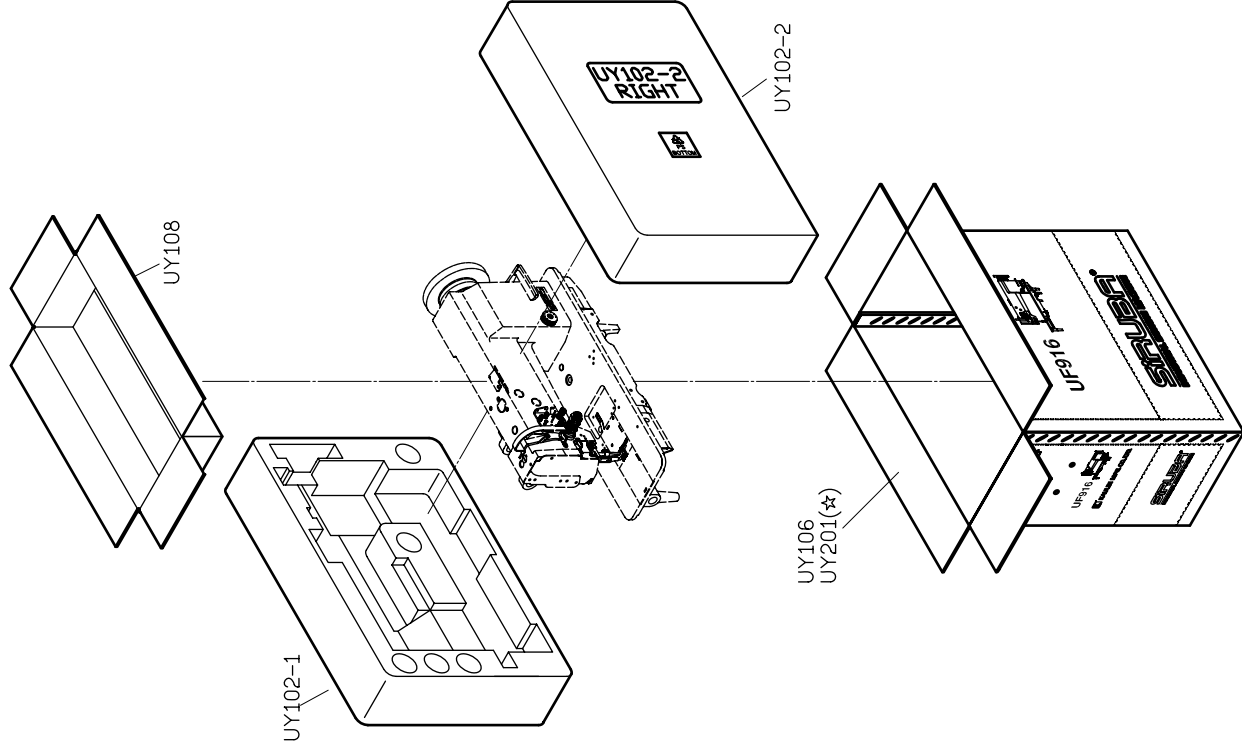

★USE FOR UF926/UF926 TRIMMER



UF926/UF926^{WITH} TRIMMER

高林股份有限公司 KAULIN MFG. CO., LTD.